



Centre Jean PERRIN

Centre de Lutte contre le Cancer d'Auvergne

Clermont-Ferrand - France -



Echange de données informatiques de traçabilité en Auvergne-Loire

Anne Doly

AIRSEH - 16 Novembre 2010





Echange de Données Informatiques de Traçabilité en Auvergne-Loire

Auvergne-Loire : EFSAuLo reçoit la prescription informatisée de PSL

Travail mutualisé de plusieurs ES depuis 2005

Dr. Eric Ducher, Dr. Soizic Ducroz, Dr. Pascale Oriol, Dr. Jean-Jacques Veillard,
Jean Casteuble, Anne Doly



AUVERGNE-LOIRE



Dr. Pierre Fressy
Dr. Marie-Odile Mansard

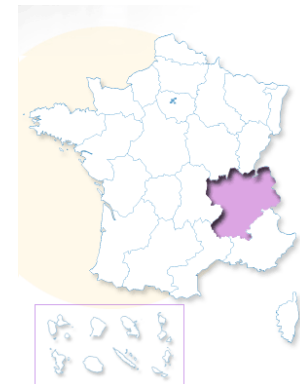



Echange de Données Informatiques de Traçabilité en Auvergne-Loire

K. Kétari (2003), Pr. O.Garraud (2004), P-L. Reichstadt (2006),
P. James (2006), F. Bru (2007)

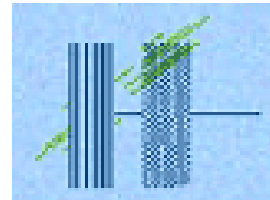

Daniela Parrot (CNIL), Mariane Cimino (GIP-CPS), Sophie Rognon (CR Auvergne),
Arlette Delbosc (CRH Franche-Comté)



Préfecture de Région Auvergne
Conseil Régional d'Auvergne





PRAI e-nnovergne LifeGrid
Avec le soutien de l'Union Européenne (FEDER)



Interopérabilité, mutualisation, normes

Territoire de l'EFSAuLo, territoire de santé

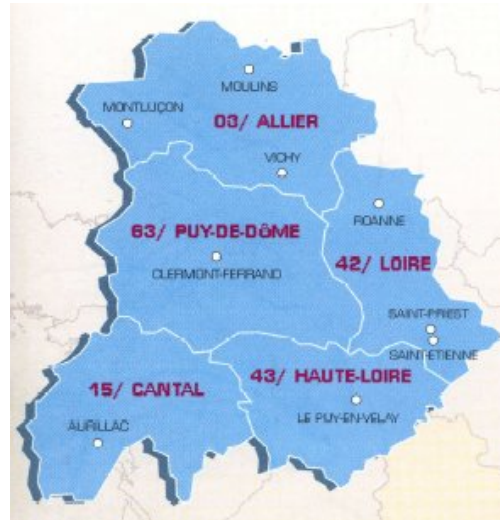
71 établissements
transfuseurs



1 base de données



File active de 130.000 patients dont 19.000 transfusés
11.500 identifiés par lien ES-EDITAL
13.000 patients partagés par au moins 2 ES

Les messages échangés permettent la fédération des Identifiants Permanents d'un même Patient dont le parcours de soins implique plusieurs établissements

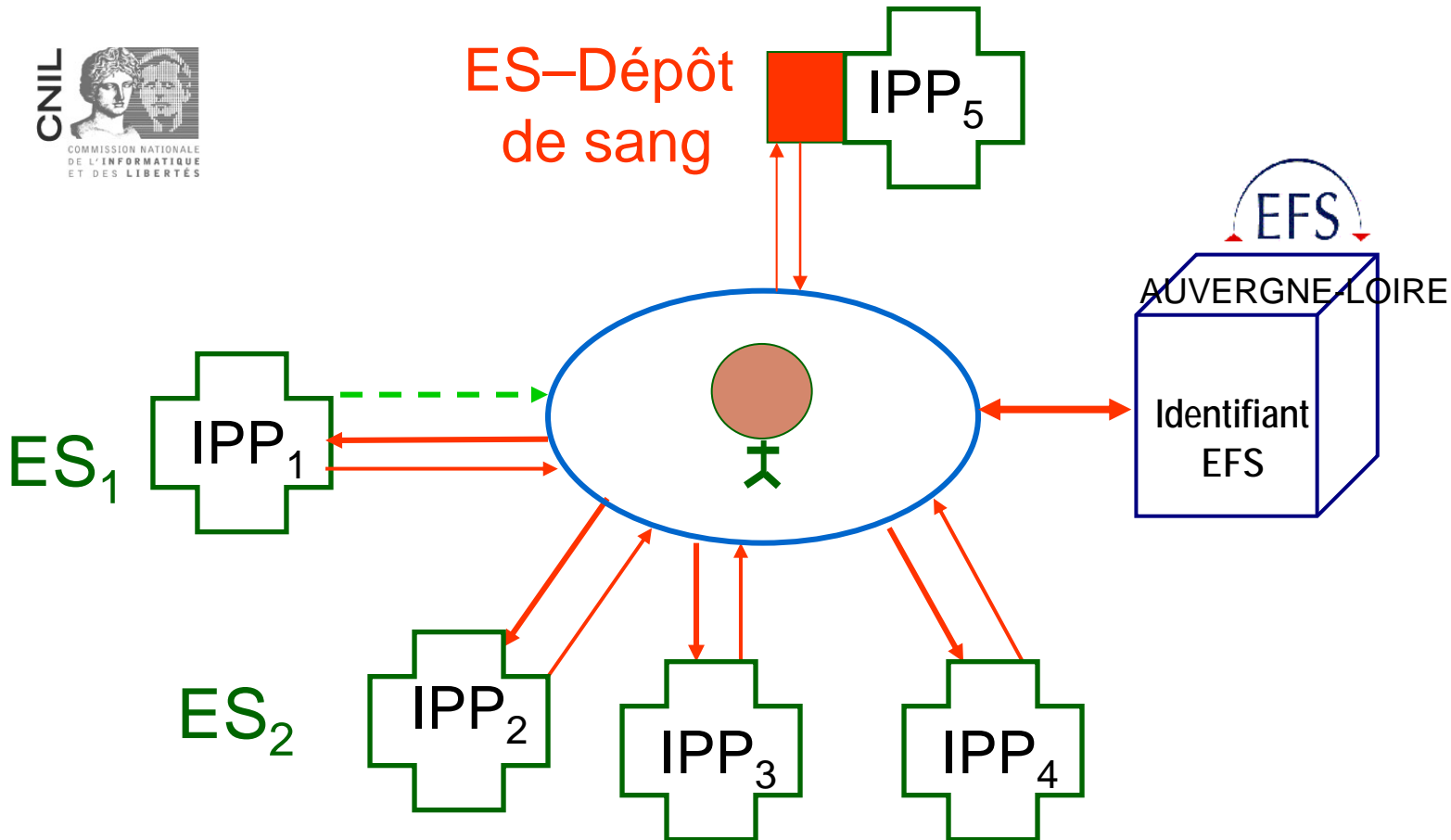

Auvergne-Loire 700 vérifications d'identité par jour
EPSOS European Patient Smart Open Services *Fredrik Linden*

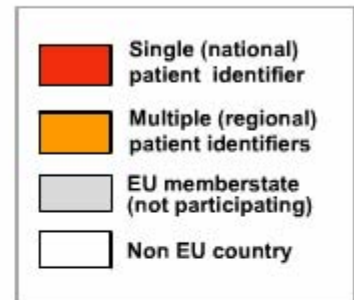

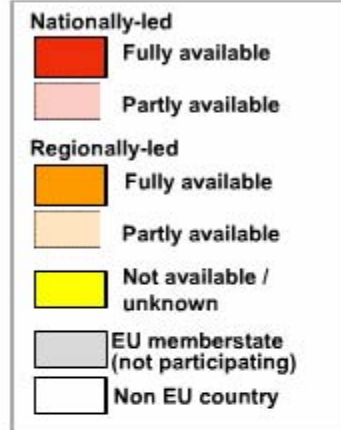
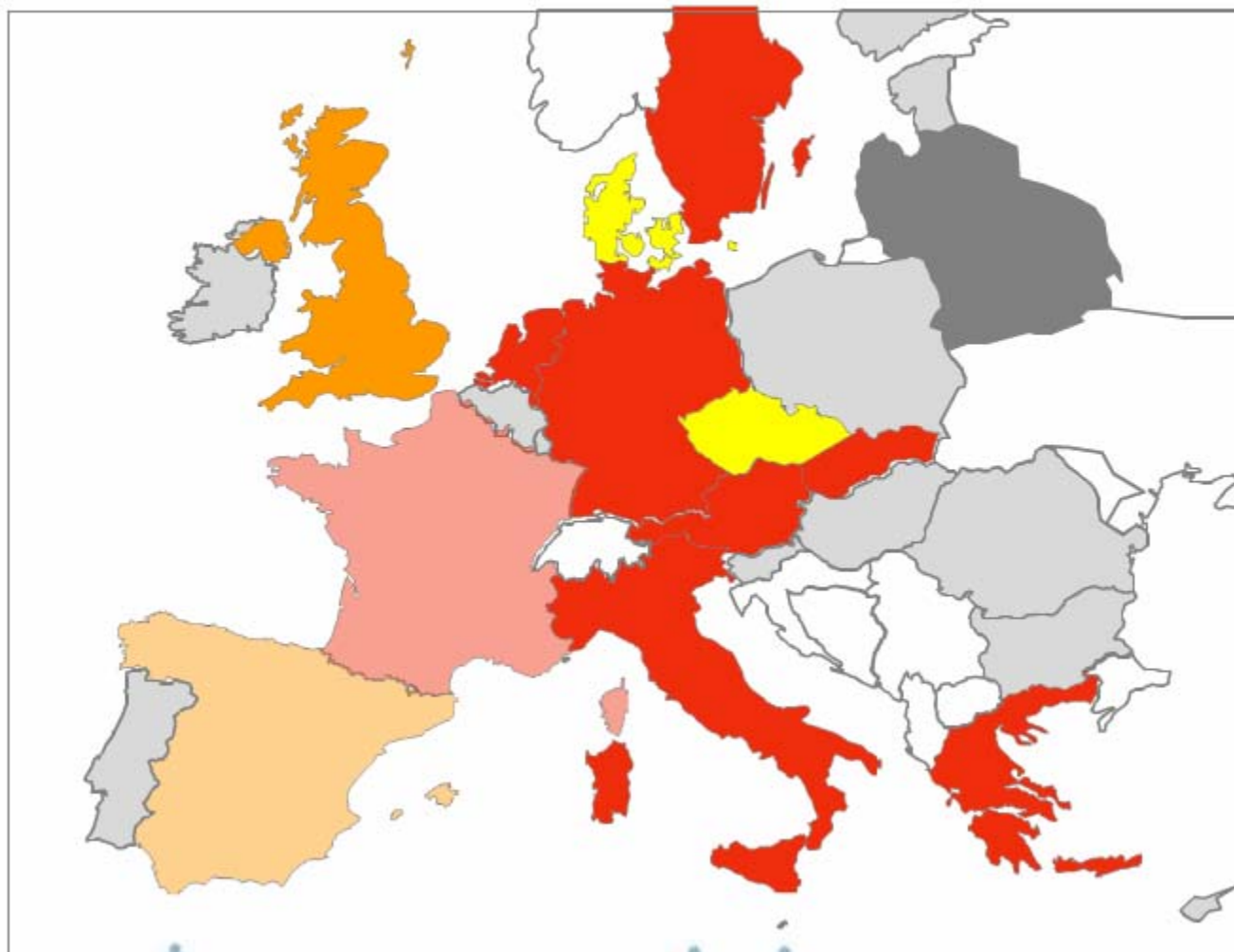

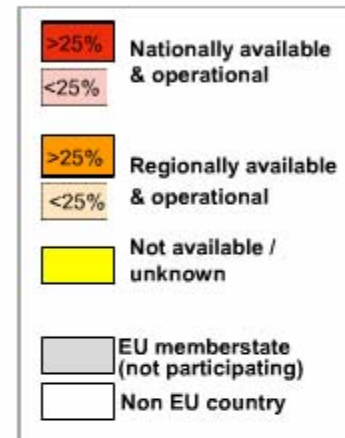
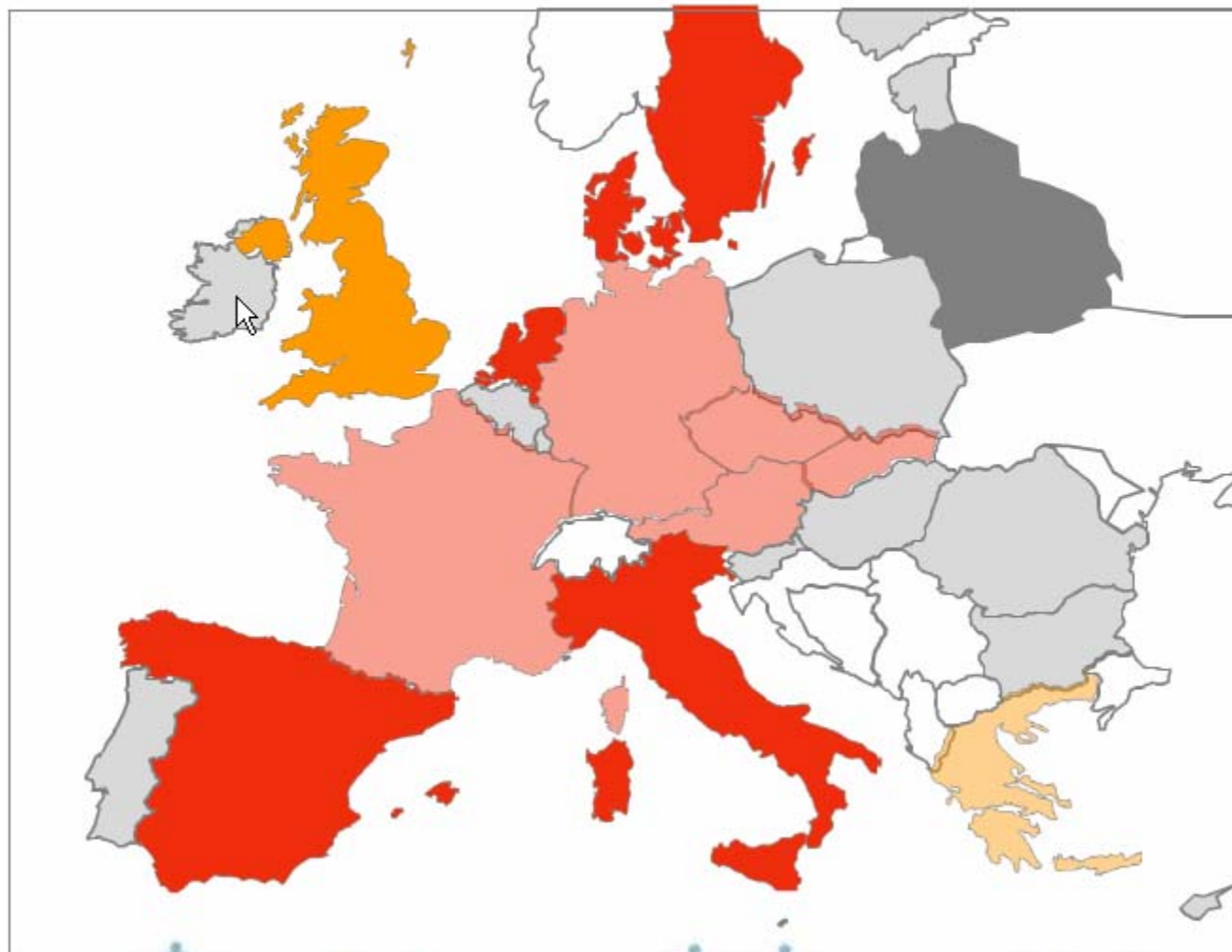

Principes mis en œuvre dès 2004

- Convention EDITAL à l'initiative du Dr.P. Fressy
- Charte EDITAL pour ES non-Médinfo
- Annexe de la Charte pour ES Médinfo
- Engagement de l'EFSAuLo, d'AUVERDATA et de Médinfo
- Contrat de licence proportionnel à la consommation de PSL
- Brioude, Issoire, Montluçon, Moulins, St-Flour, Thiers, CJP, ICL
- EDITAL 1 : DMP d'hémovigilance, CNIT, CNIL

MESSAGES-PIVOTS POUR PSL EN AUVERGNE-LOIRE

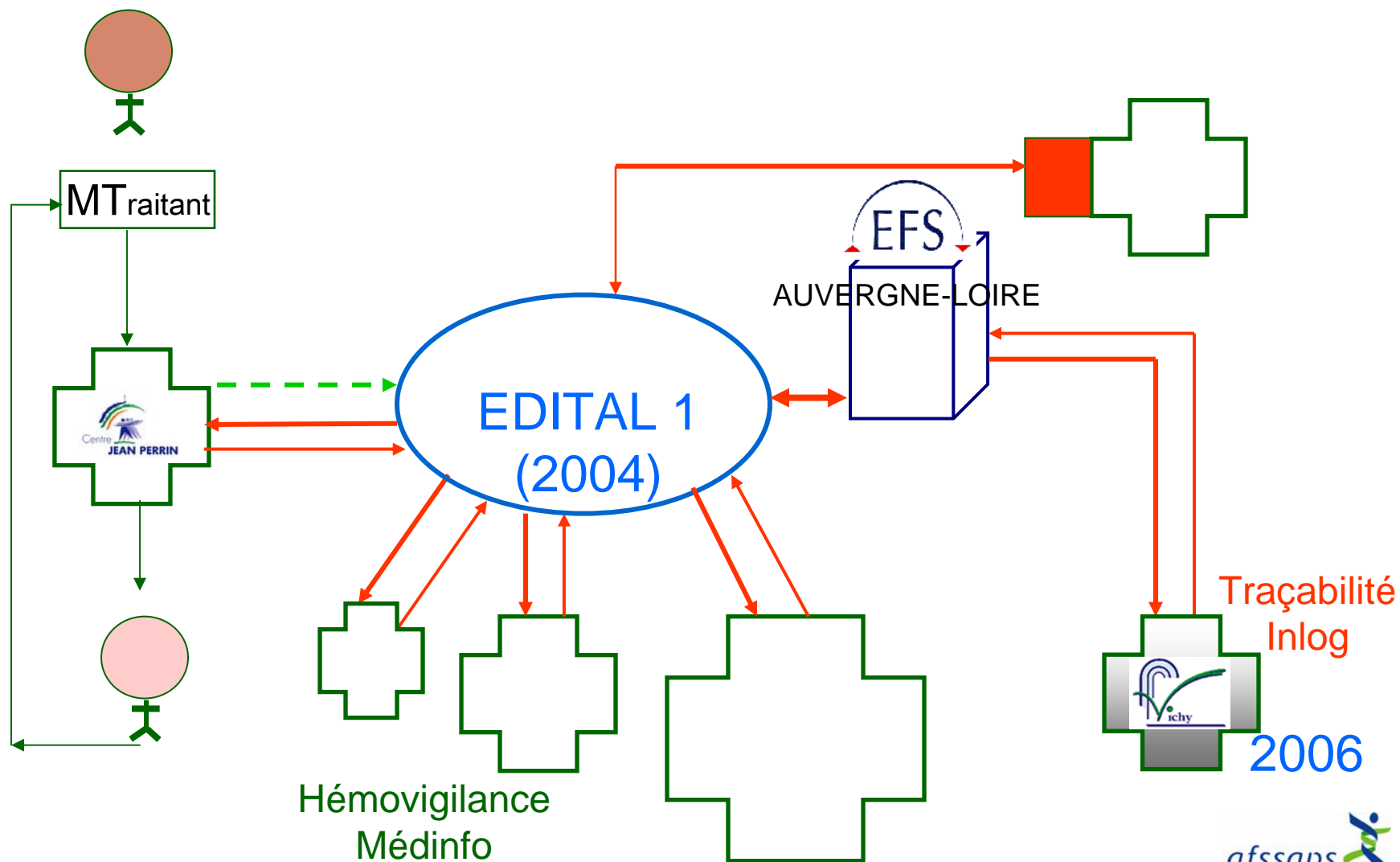

EDITAL 2 du 5 Déc. 2006 au 17 Nov. 2008

Expertise du dossier Dr Cyril Caldani, Me Anne Coat-Rames

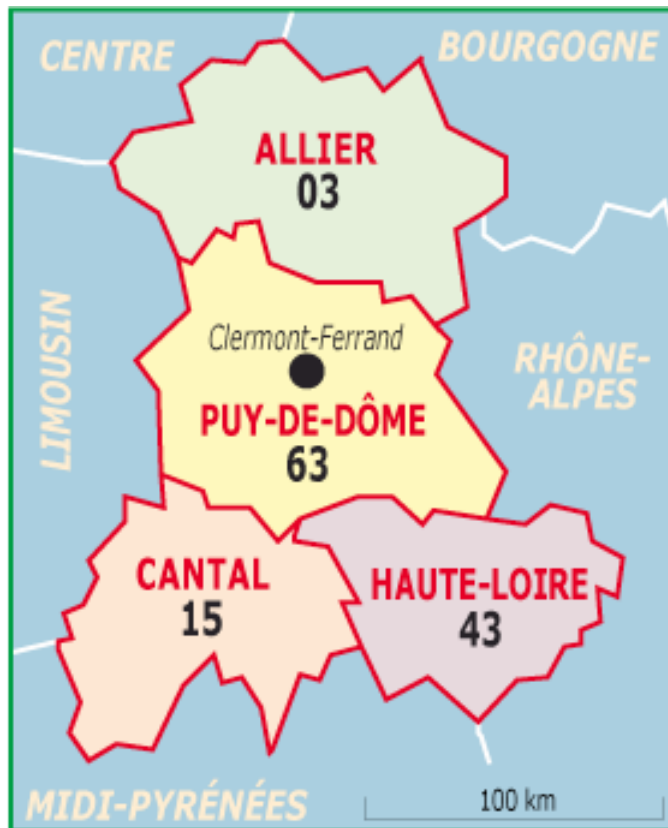

AUVERDATA

Cahier des charges
Equipe LifeGrid



Audits

DMS Conseil, Lacave-Allemand Consultants

120 K€ en fait **137 K€**

60 K€ FEDER, 24 K€ FNADT,
32 K€ MAINH, 5 K€ CR Auvergne
12 K€ CG PdD, 4 K€ CG Cantal



EDITAL 2 base de données mutualisée

Base de données de Saint-Etienne répliquée en Auvergne en temps réel

Authentification du praticien par CPS

Application Web - Lancement le 19/11/2008

- ~ Centre Jean Perrin, porteur projet
- ~ EFS Auvergne-Loire
- ~ Médinfo, prestataire informatique
- ~ Les établissements adhérents d'EDITAL bénéficient du développement
- ~ Autorités de Validation

CNIL, GIP-CPS, GIP-DMP, GMSIH, AFSSAPS



**CONSEIL RÉGIONAL
AUVERGNE**



PRAI e-nnovergne LifeGrid
Avec le soutien de l'Union Européenne (FEDER)

Accès Web à tout Praticien de Santé authentifié



carte de professionnel de santé



URML
AUVERGNE



Dépôt de sang



EDITAL 2
2008

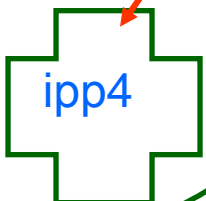
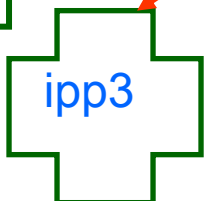
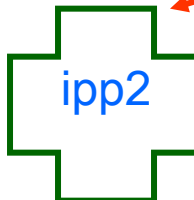
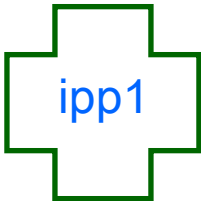
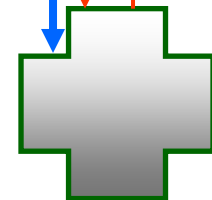
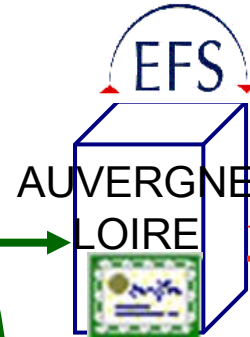

DRASS Auvergne

Le DMP en confiance

Différents besoins de sécurisation

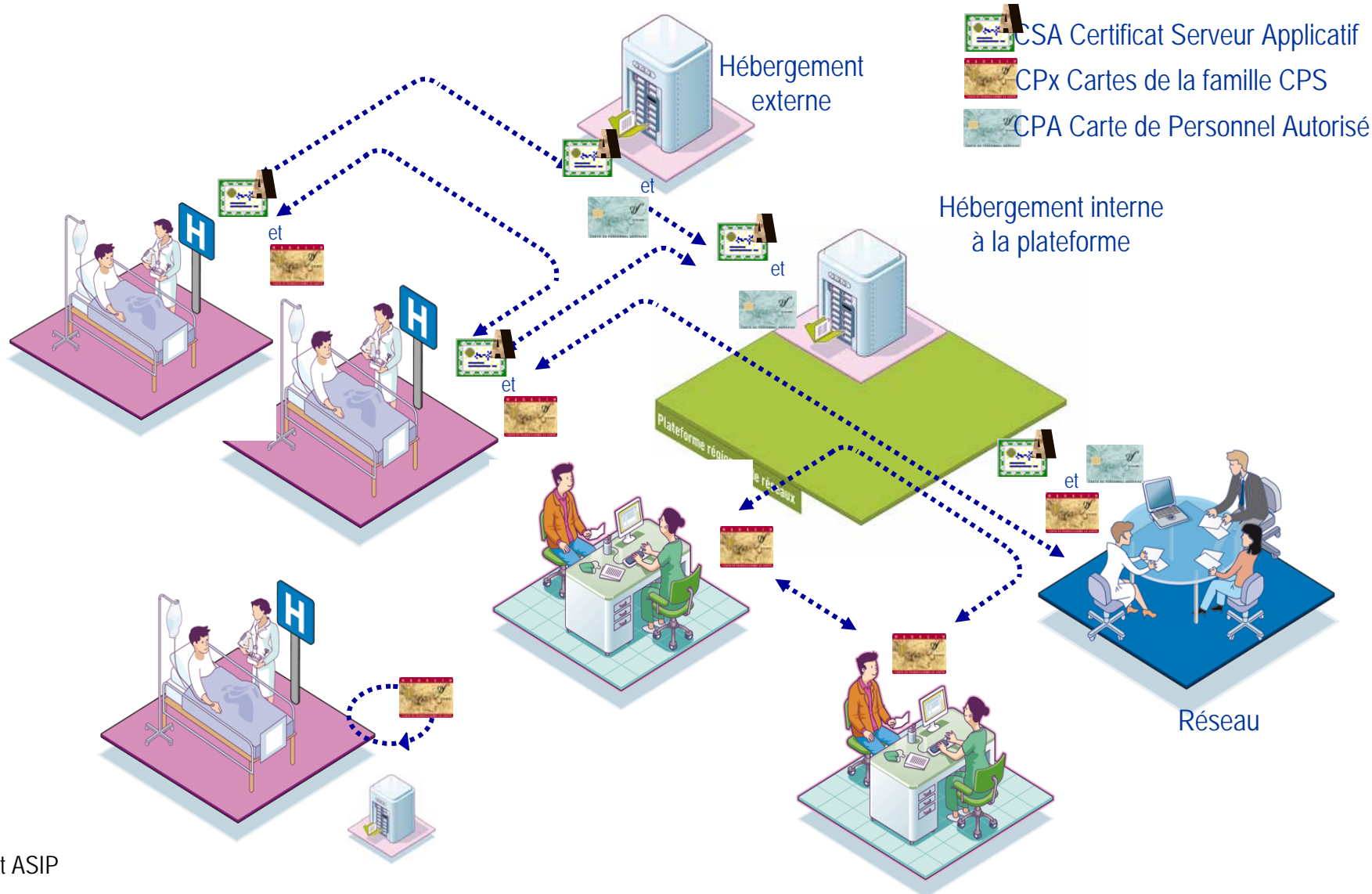

Traçabilité des PSL et sécurisation de l'identification du patient

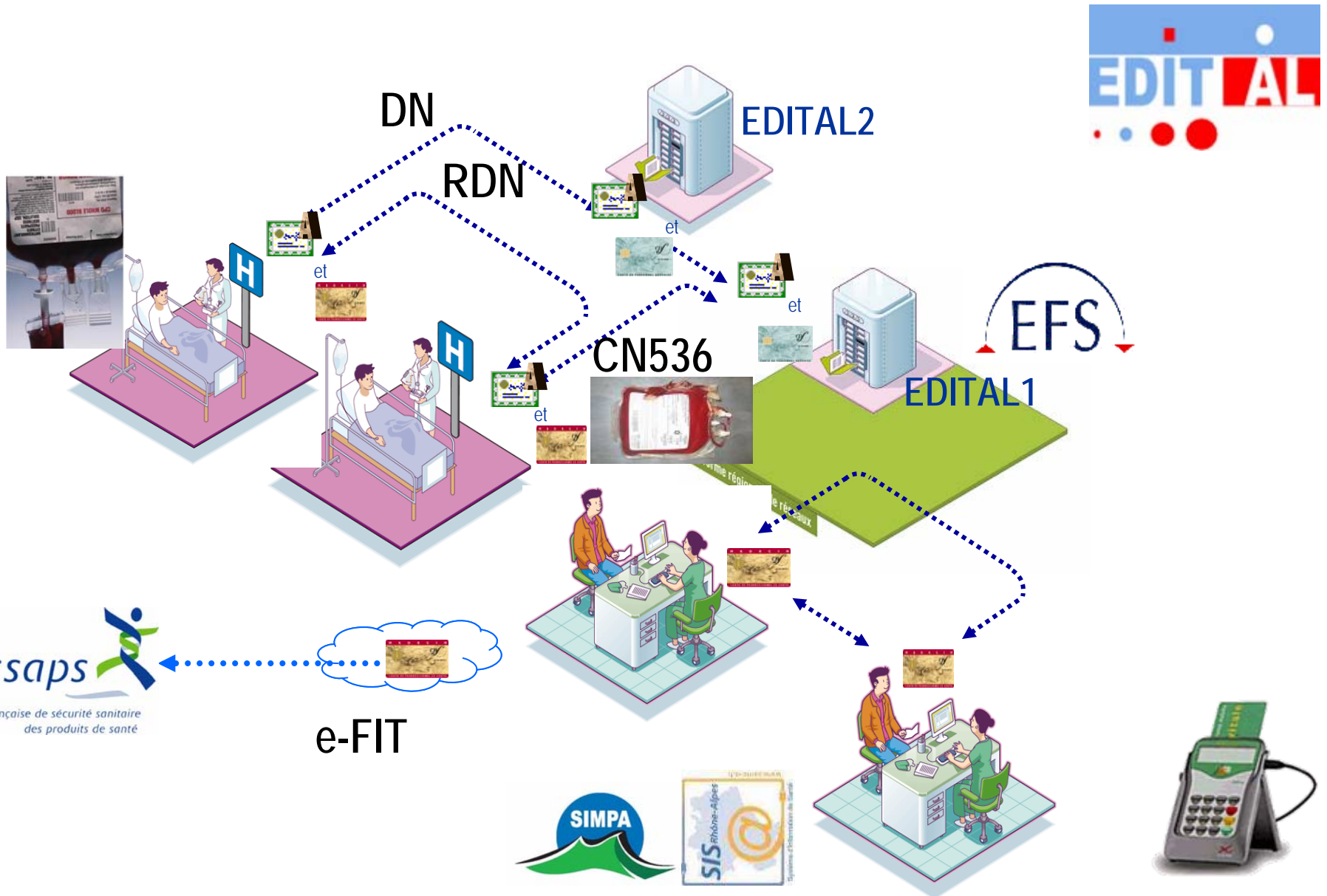



carte de professionnel de santé

EDITAL, Propagation de l'INSc

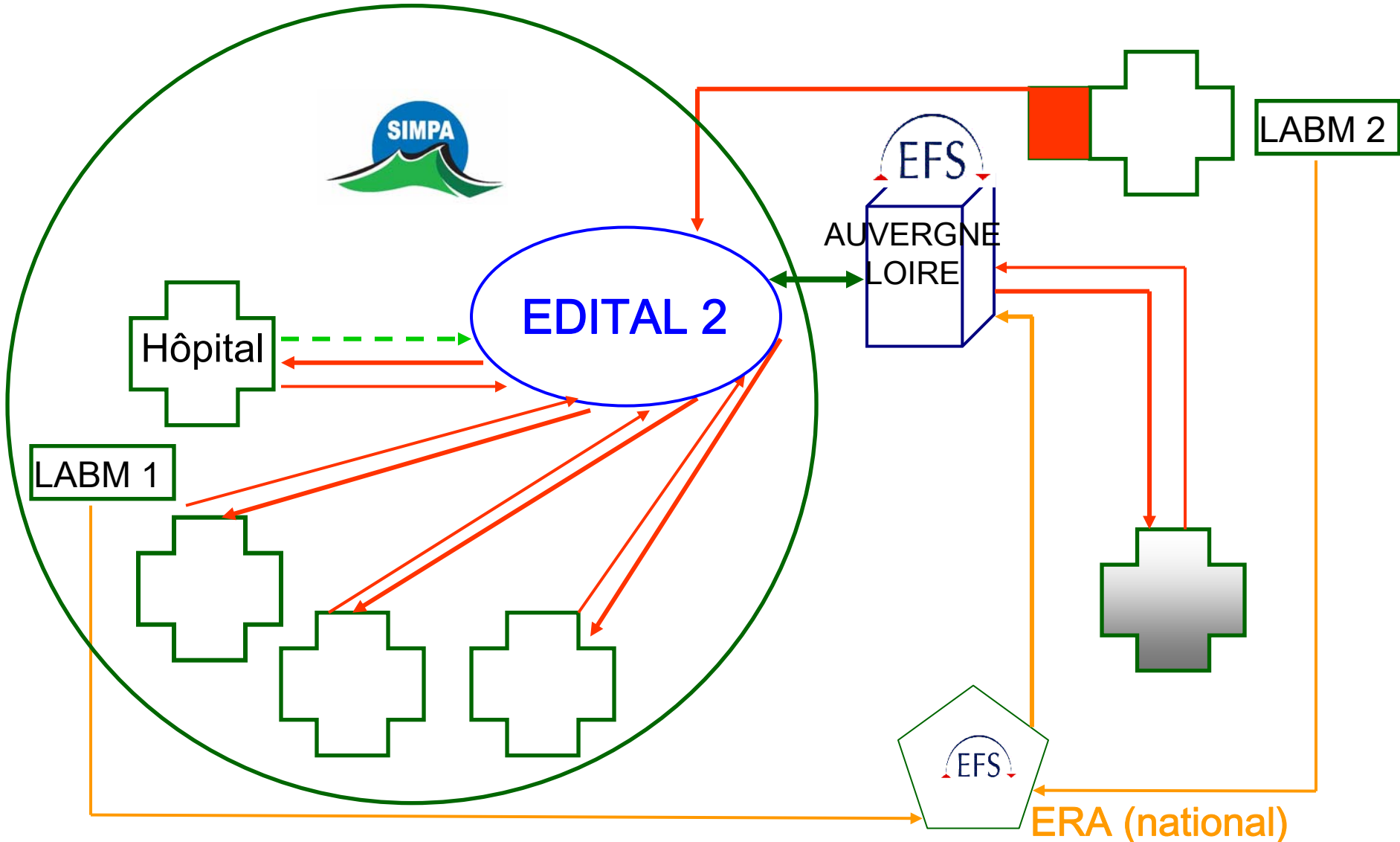

2009-2010

- EDITAL hémovigilance → identitovigilance
- Renouvellement des serveurs EDITAL2
- Travail sur la biologie des dépôts: P.Combe, Th. Guyard
- Projet d'interconnexion par RENATER de 17 bases EDITAL

- GIP-CPS fondu dans l'ASIP
- SFIL scénarios de signature électronique
- InteropSanté, Connectathon
- AFSSAPS- AFNOR, dématérialisation CN

- EFS, risque numérique identifié sur les échanges de résultats d'immuno-hématologie (ERA)
ASIP publie le cadre d'interopérabilité des SI de santé
- Le 9 Novembre 2010 l'ASIP lance un appel à projets pour le partage de CR structurés de biologie

Connectathon 13.04.2010



Projet de signature électronique des résultats de laboratoire + interconnexion des bases territoriales associées à chaque EFS

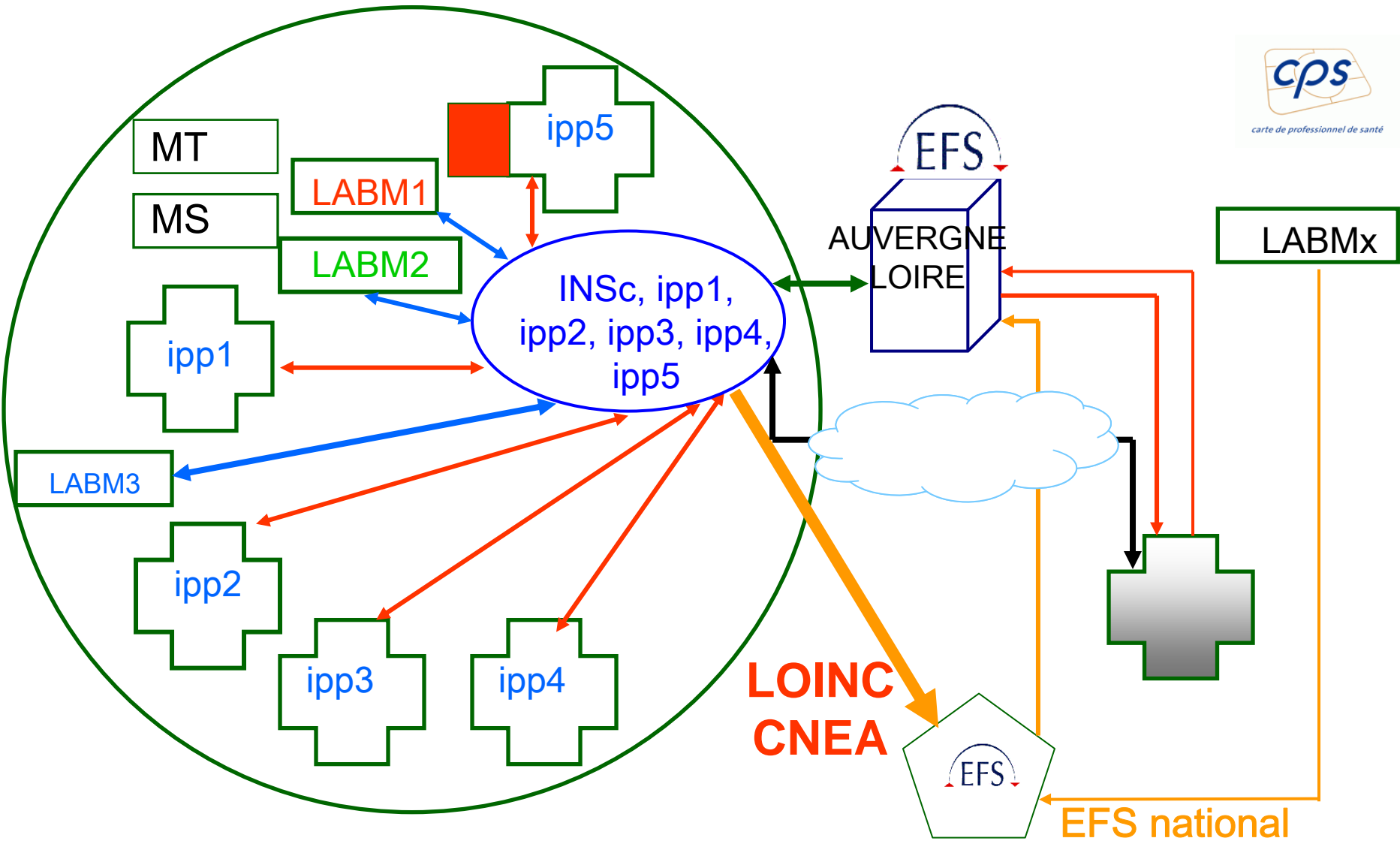

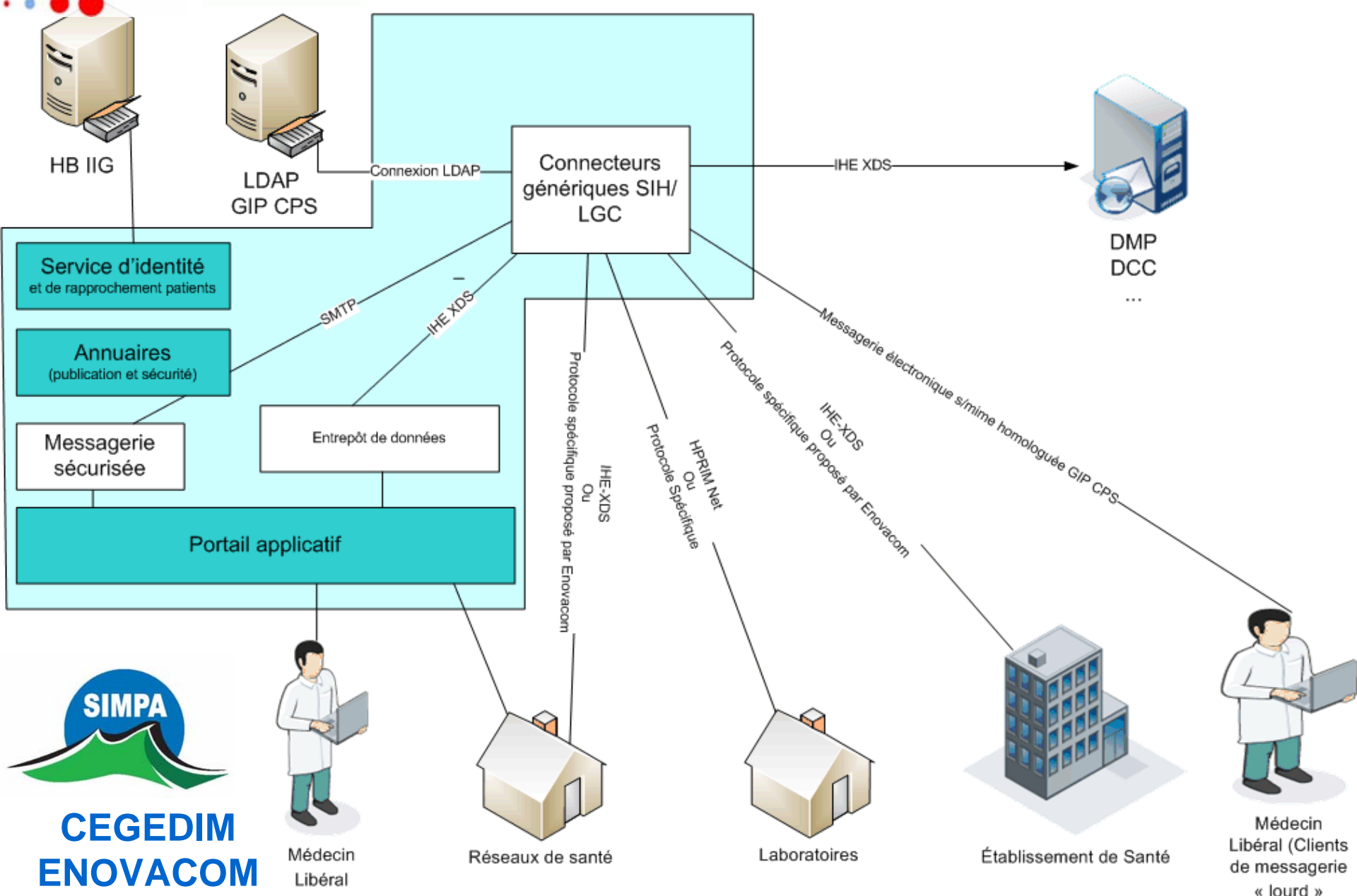

Merci pour votre attention



www.edital.fr

Edital2.Lifegrid.fr/Edital2Web

anne.doly@cjp.fr

jean.casteuble@efs.sante.fr